

UMAX



- EN
- CZ
- SK

visionbook™ 14Wg Pro

GETTING TO KNOW YOUR LAPTOP

camera

on/off button

UMAX

micro SD

USB 3.0

headphones+microphone

power

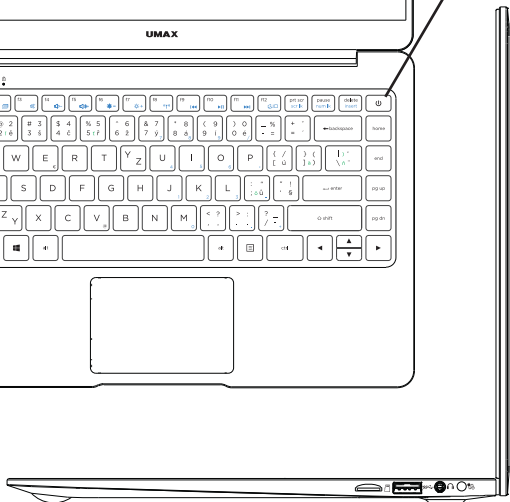
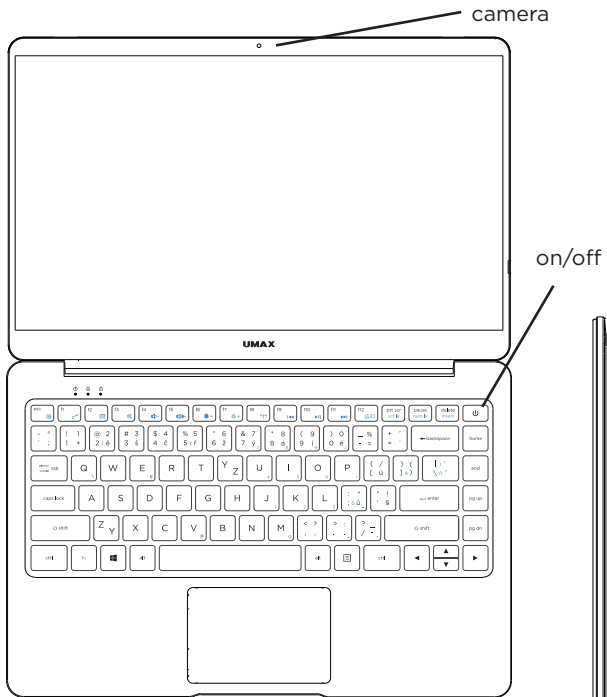

USING THE TOUCHPAD

Slide horizontally

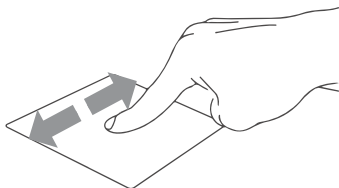

Slide vertically

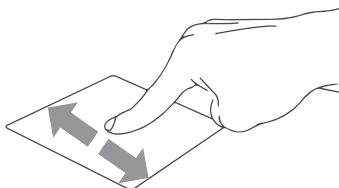

Slide diagonally

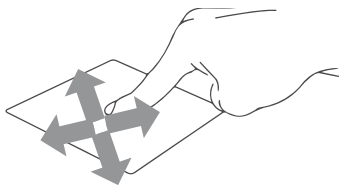

Tap/Double tap

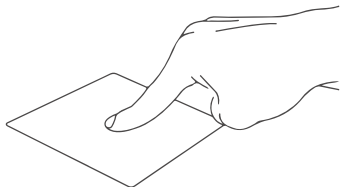

Tap and app to select it.

Double tap an app to launch it.

Drag and drop

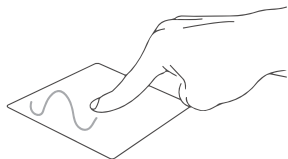

Double tap an item then slide the same finger without lifting it off the touchpad.

To drop the item to its new location lift your finger.

Left click

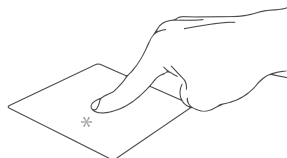

Click an app to select it.

Double click an app to launch it.

Right click

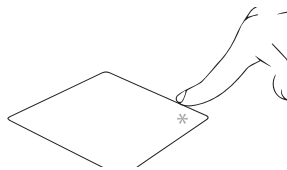

Click to open the **right-click** menu.

Two finger tap

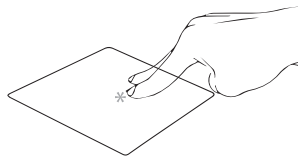

Tap two fingers to simulate the **right-click** function.

Two finger scroll (up/down)

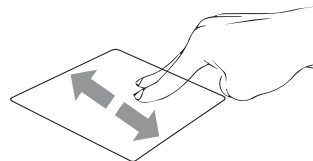

Slide two fingers up or down to **scroll**.

Two finger scroll (left/right)

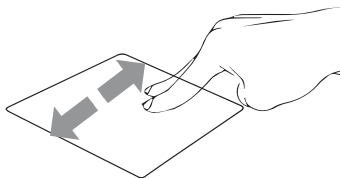

Slide two fingers left or right to scroll.

Zoom out

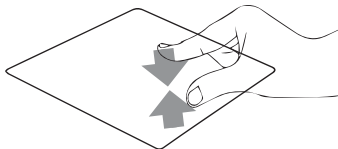

Bring together two fingers to zoom out.

Zoom in

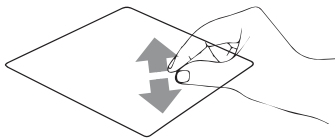

Spread apart your two fingers to zoom in.

Two finger drag and drop



Select an item and then press and hold the left button. Using your other finger slide on the touchpad to drag the item.

Three finger tap



Tap three fingers to invoke **Cortana**.

Three finger swipe left/right



Swipe three fingers left or right to switch between open apps.

Three finger swipe up



Swipe three fingers up to open **Task View**.

Three finger swipe down

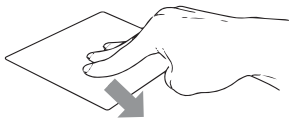











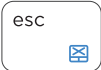











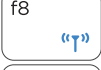

Swipe three fingers down to show **desktop**.

Four finger tap

































Tap four fingers to invoke **Action Center**.

USING YOUR KEYBOARD

| | | | | |
|--|---|---|-----|--|
|  | + |  | esc | Enables or disables the touchpad |
|  | + |  | f1 | Puts the laptop into Sleep mode |
|  | + |  | f2 | Turns the display on or off |
|  | + |  | f3 | Turns the speaker on or off |
|  | + |  | f4 | Turns the speaker volume down |
|  | + |  | f5 | Turns the speaker volume up |
|  | + |  | f6 | Decreases display brightness |
|  | + |  | f7 | Increases display brightness |
|  | + |  | f8 | Turns Airplane mode on or off |
|  | + |  | f9 | Skip to previous track or rewind |
|  | + |  | f10 | Play or pause |
|  | + |  | f11 | Skip to next track or fast forward |
|  | + |  | f12 | Toggles the display mode |

WORKING WITH WINDOWS® 10

- | | | | |
|--|---|---|--|
|  | | Launches the Start menu | |
|  | + |  | Launches Action Center |
|  | + |  | Launches the desktop |
|  | + |  | Launches the File Explorer |
|  | + |  | Opens the Share panel |
|  | + |  | Launches Settings |
|  | + |  | Launches Connect panel |
|  | + |  | Activates the Lock screen |
|  | + |  | Minimizes all currently active windows |
|  | + |  | Launches Search |

| | | | |
|--|---|---|--|
|  | + |  | Launches Project panel |
|  | + |  | Opens the Run windows |
|  | + |  | Opens Ease of Access Center |
|  | + |  | Opens the context menu of the Start button |
|  | + |  | Launches the magnifier icon and zooms in your screen |
|  | + |  | Zooms out your screen |

WINDOWS 10 TIPS

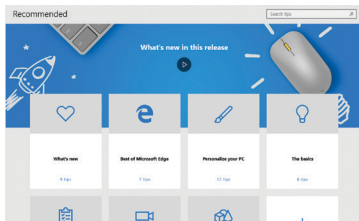

The **Tips** app in Windows 10 is full of short-and-sweet tips that help you get the most out of Windows 10

Select the **Start** button, type **tips**, and then select **Tips** at the top of the list of results.

SWITCH OUT OF S MODE IN WINDOWS 10

Windows 10 in S mode is designed for security and performance, exclusively running apps from the Microsoft Store. If you want to install an app that isn't available in the Microsoft Store, you'll need to switch out of S mode. Switching out of S mode is one-way. If you make the switch, you won't be able to go back to Windows 10 in S mode. There's no charge to switch out of S mode.

1. On your PC running Windows 10 in S mode, open **Settings > Update & Security > Activation**.
2. In the **Switch to Windows 10 Home** section, select **Go to the Store**. (If you also see an "Upgrade your edition of Windows" section, be careful not to click the "Go to the Store" link that appears there.)
3. On the **Switch out of S mode** page that appears in the Microsoft Store, select the **Get** button. After you see a confirmation message on the page, you'll be able to install apps from outside of the Microsoft Store.

TECHNICAL SUPPORT AND SERVICE CENTER

Phone : +420 800 118 629

Email: servis@umax.cz

Umax Czech a.s.
Kolbenova 962/27e
198 00 Prague 9
Czech Republic

SEZNÁMENÍ S NOTEBOOKEM

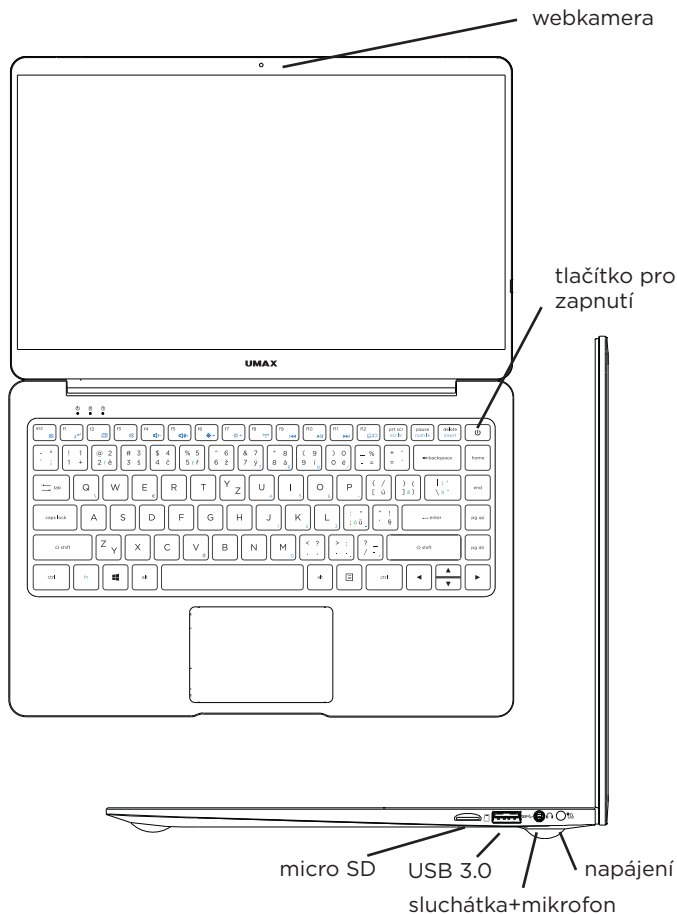

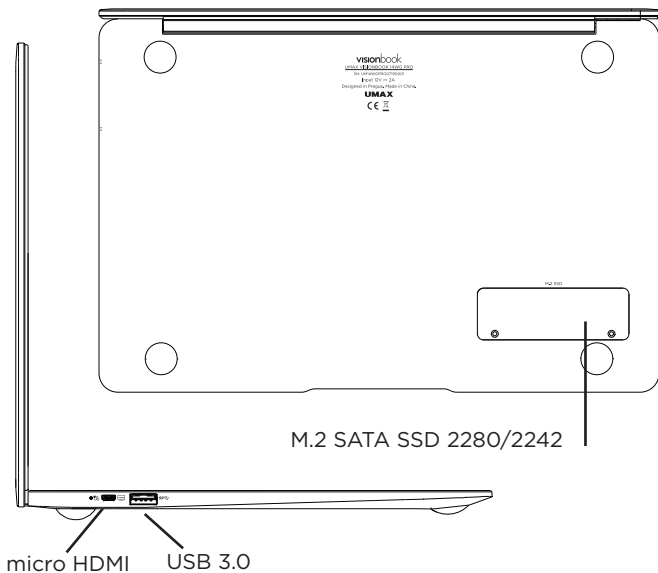

ZAPNUTÍ POČÍTAČE



POUŽÍVÁNÍ TOUCHPADU

Vodorovný posun

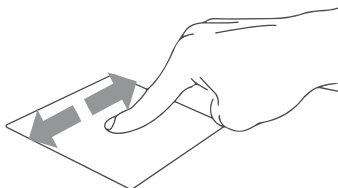

Svislý posun

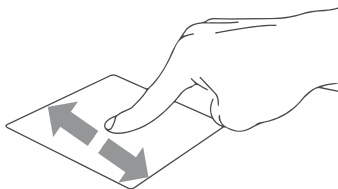

Úhlopříčný posun

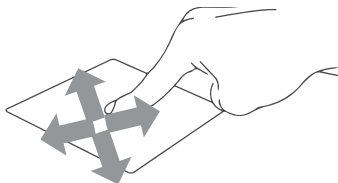

Klepnutí/dvojité klepnutí

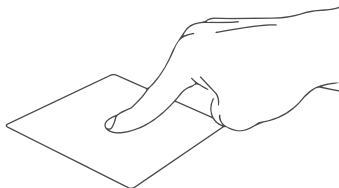

Klepnutím na aplikaci ji vyberete.

Poklepáním na aplikaci ji spustíte.

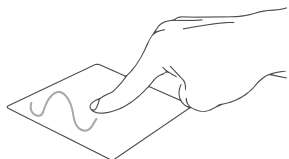
Přetažení

Poklepejte na položku a poté táhněte stejným prstem aniž byste jej zvedli.

Položku dáte na nové místo zvednutím prstu.

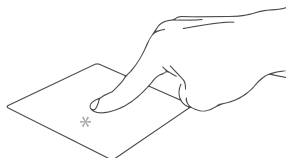
Levé kliknutí

Kliknutím vyberete aplikaci.

Dvojitým kliknutím spustíte aplikaci.

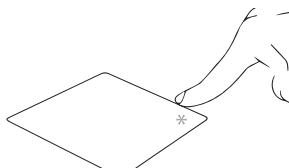
Pravé kliknutí

Kliknutím otevřete nabídku **pravého kliknutí**.

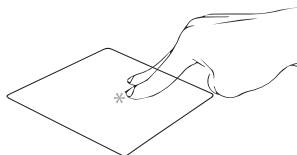
Klepnutí dvěma prsty

Klepnutím dvěma prsty simulujete nabídku **pravého kliknutí**.

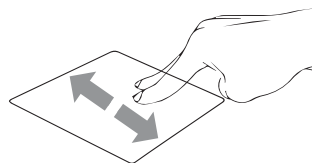
Potažení dvěma prsty (nahoru/dolů)

Tahem dvou prstů rolujete nahoru nebo dolů.

Potažení dvěma prsty (doleva/doprava)

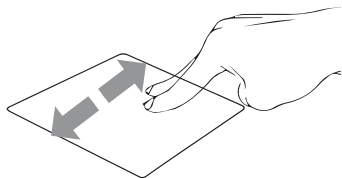

Tahem dvou prstů rolujete doleva a doprava.

Zmenšení

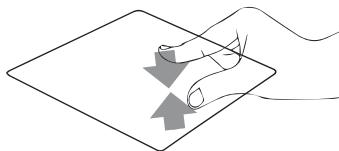

Táhněte dva prsty k sobě pro zmenšení.

Zvětšení

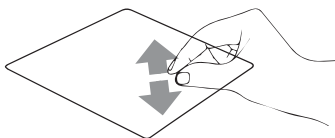

Roztáhněte dva prsty od sebe pro zvětšení.

Tažení dvěma prsty

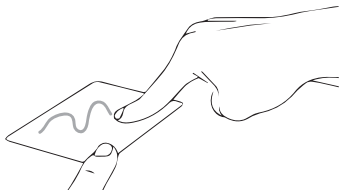

Vyberte položku a stiskněte a držte tlačítko levého kliknutí. Tažením druhého prstu přetáhněte položku a zvednutím prstu ji uvolněte.

Klepnutí třemi prsty

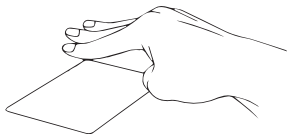

Klepnutím třemi prsty spustíte Cortanu.

Potáhnutí třemi prsty doleva/doprava



Potáhnutím třemi prsty doleva nebo doprava přepnete mezi otevřenými aplikacemi.

Potáhnutí třemi prsty nahoru



Potáhnutím třemi prsty nahoru spustíte Zobrazení úloh.

Potáhnutí třemi prsty dolu















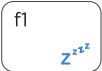

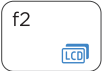







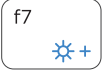

Potáhnutím třemi prsty dolu zobrazíte desktop.

Klepnutí čtyřmi prsty

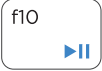

Klepnutím čtyřmi prsty spustíte Centrum akcí.

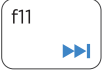
KLÁVESNICE

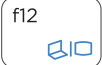
| | | | |
|--|---|---|--|
|  | + |  | Aktivace a deaktivace touchpadu |
|  | + |  | Přepne notebook do režimu spánku |
|  | + |  | Zapnutí a vypnutí displeje |
|  | + |  | Zapnutí a vypnutí reproduktoru |
|  | + |  | Snížení hlasitosti reproduktoru |
|  | + |  | Zvýšení hlasitosti reproduktoru |
|  | + |  | Snížení jasu displeje |
|  | + |  | Zvýšení jasu displeje |
|  | + |  | Aktivuje a deaktivuje režim letadlo |
|  | + |  | Přeskočit na předchozí stopu |
|  | + |  | Přehrát nebo pozastavit |
|  | + |  | Přeskočit na následující stopu |
|  | + |  | Přepínání režimu zobrazení |

PRÁCE S WINDOWS® 10

- | | | | |
|--|---|---|----------------------------------|
|  | | Spustí Start menu | |
|  | + |  | Spustí Centrum akcí |
|  | + |  | Spuštění režimu pracovní plochy |
|  | + |  | Spustí Průzkumník souborů |
|  | + |  | Otevře panel Sdílet |
|  | + |  | Spustí Nastavení |
|  | + |  | Spustí panel Připojit |
|  | + |  | Aktivace zámku obrazovky |
|  | + |  | Minimalizuje aktivní okna |
|  | + |  | Spustí Hledání |

| | | | |
|--|---|---|---|
|  | + |  | Spustí panel Nastavení zobrazení |
|  | + |  | Otevření okna Spustit |
|  | + |  | Otevření Centra snadného přístupu |
|  | + |  | Otevře místní nabídku tlačítka Start |
|  | + |  | Spuštění lupy umožňující zvětšení části obrazovky |
|  | + |  | Zmenšení zobrazení |

WINDOWS 10 TIPY

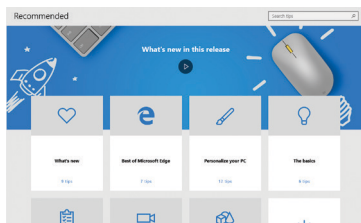

Aplikace **Tipy** v systému Windows 10 je plná krátkých užitečných tipů, které vám pomohou naplno využít možnosti počítače se systémem Windows 10.

Vyberte tlačítko **Start**, napište **tipy** a pak nahoře v seznamu výsledků vyberte **Tipy**.

VYPNUTÍ REŽIMU S VE WINDOWS 10

Systém Windows 10 v režimu S je navržený s ohledem na zabezpečení a výkon a můžou se v něm spouštět výhradně jen aplikace z obchodu Microsoft Store. Pokud chcete nainstalovat aplikaci, která není k dispozici v obchodě Microsoft Store, budete muset režim S přestat používat. Přechod z režimu S je jednosměrný. Pokud přejdete, nebudete se moci vrátit zpět k systému Windows 10 v režimu S. Ukončení používání režimu S je bezplatné.

1. Na počítači se systémem Windows 10 v režimu S otevřete **Nastavení > Aktualizace a zabezpečení > Aktivace**.

2. V části **Přepnout na Windows 10 Home** vyberte **Přejít do Storu**. (Pokud se zobrazuje i část „Upgradujte svou edici Windows“, dejte pozor, abyste nekliknuli na odkaz Přejít do Storu, který se zobrazuje tam.)

3. Na stránce označené **Přepnout z režimu S**, která se zobrazí v obchodě **Microsoft Store**, vyberte tlačítko **Získat**. Jakmile se na stránce zobrazí potvrzovací zpráva, budete moci instalovat aplikace, které nepochází z obchodu Microsoft Store.

TECHNICKÁ PODPORA A SERVISNÍ CENTRUM

Telefon: 800 118 629
Email: servis@umax.cz

Umax Czech a.s.
Kolbenova 962/27e
198 00 Praha 9
Česká republika

SPOZNAJTE SVOJ NOTEBOOK

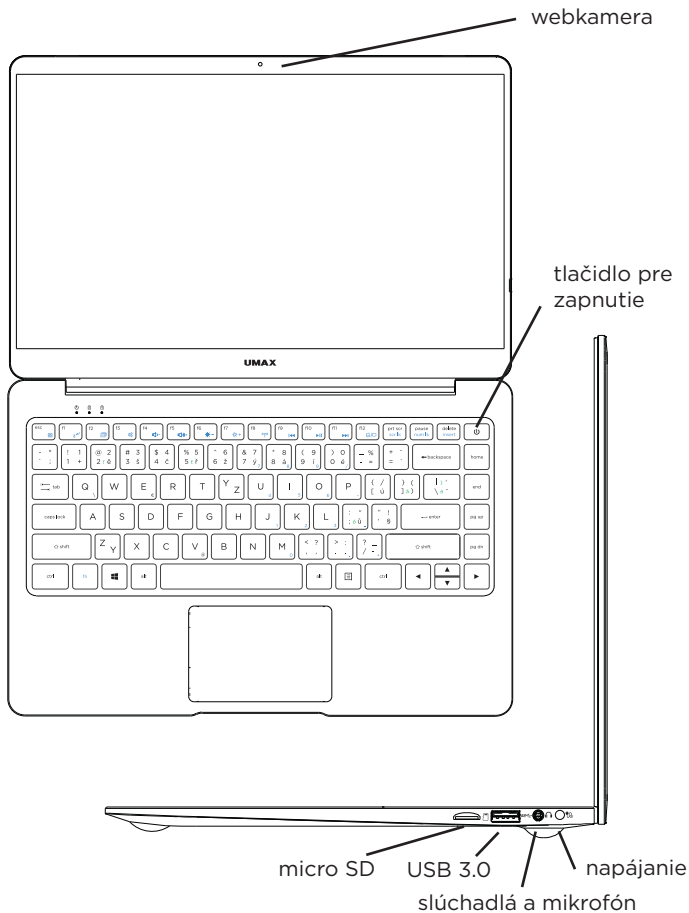

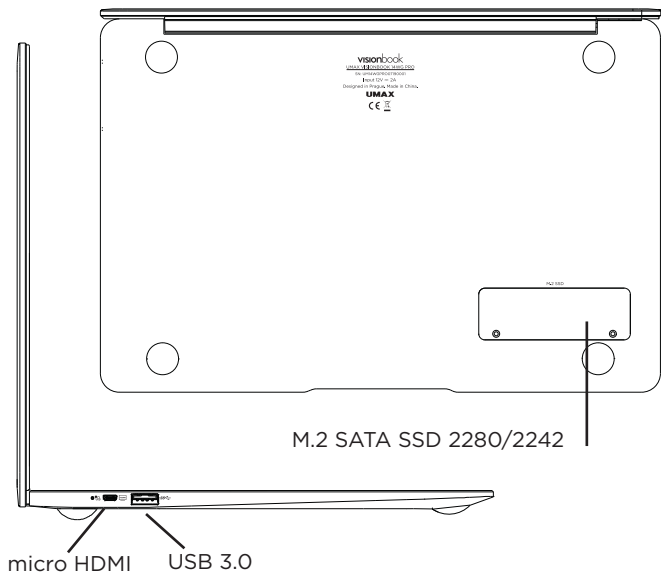

ZAPNUTÍ POČÍTAČA

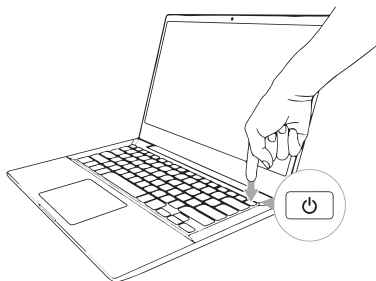

POUŽÍVANIE TOUCHPADU

Horizontálne posúvanie

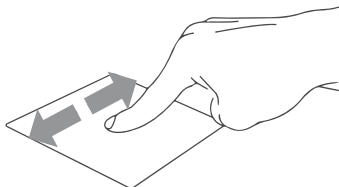

Vertikálne posúvanie

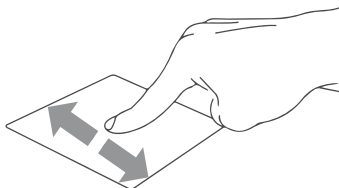

Diagonálne posúvanie

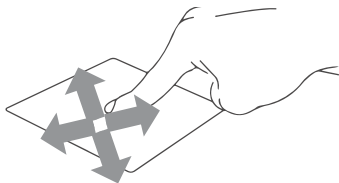

Poklepanie/dvojité poklepanie

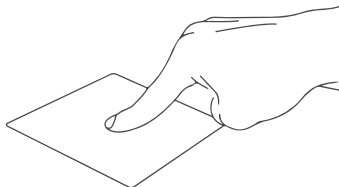

Ťuknutím na aplikáciu ju vyberete.

Dvojitým ťuknutím na aplikáciu ju spustíte.

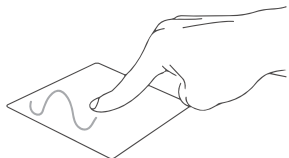
Ťahať a pustiť

Dvakrát kliknite na položku a potom ten istý prst posuňte bez toho, aby ste ho zdvihli.

Ak chcete položku položiť na nové miesto, prst zdvihnite.

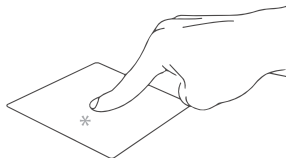
Kliknutie ľavým tlačidlom

Kliknutím vyberiete aplikáciu.

Dvojím kliknutím spustíte aplikáciu.

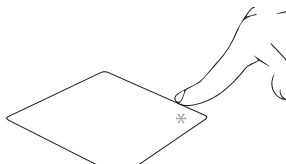
Kliknutie pravým tlačidlom

Kliknutím otvoríte ponuku **pravého kliknutí**.

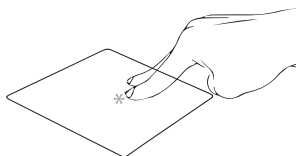
Poklepanie dvoma prstami

Ťuknite dvoma prstami ak chce simulovať kliknutie **pravým tlačidlom** myši.

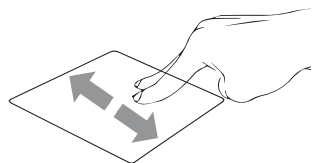
Posúvanie dvoch prstov (nahor/nadol)

Posúvajte dva prsty ak chcete posúvať položku **hore alebo dolu**.

Posúvanie dvoch prstov (doľava/doprava)

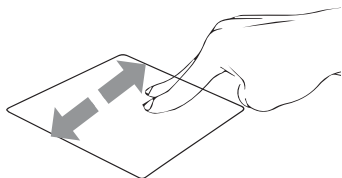

Posúvajte dva prsty ak chcete posúvať položku doľava alebo doprava.

Oddialenie

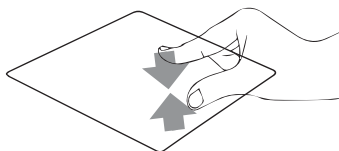

Spojte dva prsty pro oddialenie..

Priblíženie

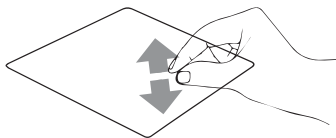

Roztiahnite dva prsty pro priblíženie.

Ťahať a pustiť dvoma prstami

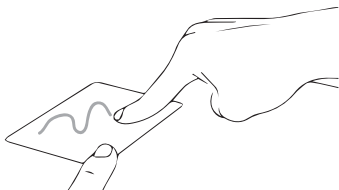

Vyberte položku a stlačte a podržte ľavé tlačidlo. Posúvaním ďalšieho prsta položku potiahnite a položte do nového umiestnenia odťahnutím prsta.

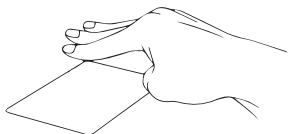
Poklepanie troma prstami

Ťuknutím troma prstami vyvoláte Cortanu.

Potiahnutie troma prstami doľava/doprava

Potiahnutím troma prstami doľava alebo doprava môžete **prepínať** medzi otvorenými aplikáciami.

Potiahnutie troma prstami hore

Potiahnutím troma prstami hore spustíte **Zobrazení úloh**.

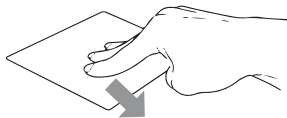



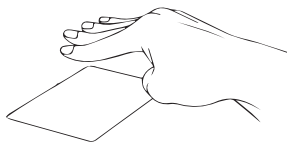







Potiahnutie troma prstami dolu

Potiahnutím troma prstami dolu zobrazíte **desktop**.

Poklepanie štyrmi prstami

Ťuknutím štyrmi prstami vyvolajte **Centrum akcií**.

KLÁVESNICA

| | | | |
|----|---|--|---|
| fn | + | esc  | Zapína alebo vypína touchpad |
| fn | + | f1  | Prepne notebook do režimu spánok |
| fn | + | f2  | Zapína alebo vypína displej |
| fn | + | f3  | Zapína alebo vypína reproduktor |
| fn | + | f4  | Znižuje hlasitosť reproduktora |
| fn | + | f5  | Zvyšuje hlasitosť reproduktora |
| fn | + | f6  | Znižuje jas displeja |
| fn | + | f7  | Zvyšuje jas displeja |
| fn | + | f8  | Zapína alebo vypína režim lietadlo |
| fn | + | f9  | Prejsť na predchádzajúcu stopu |
| fn | + | f10  | Prehrať alebo pozastaviť |
| fn | + | f11  | Prejsť na ďalšiu stopu |
| fn | + | f12  | Prepína režimu zobrazenia |

PRÁCA S WINDOWS® 10

Spúšťa ponuku **Štart**



+



Spúšťa **Centrum akcií**



+



Spustenie režimu pracovnej plochy



+



Spúšťa **Prieskumník súborov**



+



Otvára panel **Zdieľanie**



+



Spúšťa **Nastavenia**



+



Spúšťa panel **Pripojiť**



+



Slúži na aktivovanie obrazovky zamknutia



+















Minimalizuje aktívne okno



+



Spúšťa **Vyhľadať**

-  +  Spúšťa panel **Nastavenie zobrazenia**
-  +  Otvorí okno **Spustenie**
-  +  Otvorí aplikáciu **Centrum uľahčenia prístupu**
-  +  Otvára kontextovú ponuku tlačidla Start
-  +  Slúži na spustenie zväčšovacieho skla a priblíži vašu obrazovku
-  +  Slúži na oddialenie vašej obrazovky

WINDOWS 10 TIPY

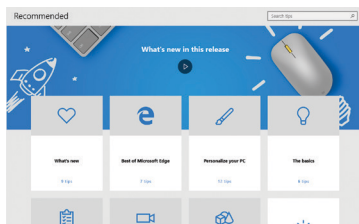

Aplikácia **Tipy** vo Windows 10 je plná stručných a užitočných tipov na čo najefektívnejšie používanie Windowsu.

Vyberte tlačidlo **Štart**, zadajte text **tipy** a potom v zozname výsledkov vyberte položku **Tipy**.

OPUSTENIE REŽIMU S VO WINDOWS 10

Windows 10 v režime S je navrhnutý s dôrazom na zabezpečenie a výkon a umožňuje spúšťať aplikácie pochádzajúce výlučne z obchodu Microsoft Store. Ak chcete nainštalovať aplikáciu, ktorá nie je k dispozícii v Microsoft Store, budete sa musieť prepnúť z režimu S. Prechod z režimu S je nevratný. Ak prechod vykonáte, nebudete sa môcť vrátiť späť na Windows 10 v režime S. Za opustenie režimu S sa neúčtuje žiadny poplatok.

1. V počítači s Windowsom 10 v režime S otvorte položku **Nastavenia > Aktualizácia a zabezpečenie > Aktivácia**.
2. V časti **Prejsť na Windows 10 Home** vyberte prepojenie **Prejsť do Storu**. (Ak sa zobrazuje časť Inovácia vášho vydania systému Windows, dávajte pozor, aby ste neklikli na prepojenie Prejsť do Storu v tejto časti.)
3. Na stránke **Opustenie režimu S**, ktorá sa zobrazí v Microsoft Store, vyberte tlačidlo **Získať**. Po zobrazení správy s potvrdením na stránke budete môcť inštalovať aj aplikácie, ktoré nepochádzajú z obchodu Microsoft Store.

TECHNICKÁ PODPORA A SERVISNÉ CENTRUM

Telefón: +420 800 118 629

Email: servis@umax.cz

Umax Czech a.s.

Kolbenova 962/27e

198 00 Praha 9

Česká republika



Do not dispose of electrical appliances as unsorted municipal waste, use separate collection facilities. Contact your local authority for information regarding the collection systems available. If electrical appliances are disposed of in landfills or dumps, hazardous substances can leak into the groundwater and get into the food chain, damaging your health and well-being. Please contact your local or regional waste authority for more information on collection, reuse and recycling programs.



Importer hereby declares that this wireless device is in compliance with the essential requirements and other relevant provisions of the R&TTE Directive and Radio Equipment Directive 2014/53/EU, as applicable. A copy of the EU Declaration of Conformity is available at www.umax.cz.

Umax, Umax logo, Visionbook and Visionbook logo are trademarks of Umax Czech a.s. Windows is a registered trademark of Microsoft Corporation. All other trademarks are the property of their respective owners.



Nevyhazujte elektrické spotřebiče jako netříděný komunální odpad, použijte oddělené sběrné zařízení. Informace o dostupných systémech sběru získáte od místního úřadu. Pokud jsou elektrické spotřebiče likvidovány na skládkách, mohou nebezpečné látky unikat do podzemních vod a dostat se do potravinového řetězce, což může poškodit vaše zdraví. Další informace o sběru, opakovaném použití a recyklačních programech vám poskytne místní nebo regionální úřad pro nakládání s odpady.



Dovozce tímto prohlašuje, že toto bezdrátové zařízení splňuje základní požadavky a další relevantní podmínky směrnice R&TTE a směrnice 2014/53/EU pro rádiová zařízení v platném znění. Prohlášení o shodě pro EU najdete na www.umax.cz

Umax, Umax logo, Visionbook a Visionbook logo jsou ochranné známky společnosti Umax Czech a.s.

Windows je ochranná známka společnosti Microsoft Corporation.

Ostatní názvy jsou ochrannými známkami příslušných vlastníků.



Nevyhadzujte elektrické spotřebiče ako netriedený komunálny odpad, použite oddelené zberné zariadenia. Informácie o dostupných systémoch zberu získate od miestneho úradu. Ak sú elektrické spotrebiče likvidované na skládkach, môžu nebezpečné látky unikáť do podzemných vôd a dostať sa do potravinového reťazca, čo môže poškodiť vaše zdravie. Ďalšie informácie o zbere, opakovanom použití a recyklačných programoch vám poskytne miestny alebo regionálny úrad pre nakladanie s odpadmi.



Dovozce týmto vyhlasuje, že toto bezdrôtové zariadenie vyhovuje základným požiadavkám a ďalším dôležitým ustanoveniam smernice R&TTE a smernice o rádiových zariadeniach 2014/53/EÚ. Kópia vyhlásenia o zhode s normami EÚ je dostupná na stránke www.umax.cz

Umax, Umax logo, Visionbook a Visionbook logo sú ochranné známky spoločnosti Umax Czech a.s.

Windows je ochranná známka spoločnosti Microsoft Corporation.

Ostatné názvy sú ochrannými známkami príslušných vlastníkov.

WEB

www.umax.cz

FACEBOOK

[Umax.cz](https://www.facebook.com/umax.cz)

YOUTUBE

UMAX Czech Republic

UMAX

© 2019 Umax Czech a.s.